



## Room Temperature Controllers with 7-Day Time Switch and LCD for heating systems

## RDE10...

---

**2-position control with ON/OFF output for heating**  
**Operating modes: normal operation and energy saving mode**  
**7-day time switch and manual operation**  
**Mains-powered AC 230 V (RDE10) or battery-powered DC 3 V (RDE10.1)**

### Use

---

The RDE10... is used for the control of the room temperature in heating systems.

Typical applications:

- Apartments
- Commercial spaces
- Schools

For the control of the following pieces of equipment:

- Thermic valves or zone valves
- Gas or oil burners
- Fans
- Pumps

## Functions

The controller acquires the room temperature with its integrated sensor and maintains the setpoint by delivering control commands. The switching differential is 1 K.

### Function diagram

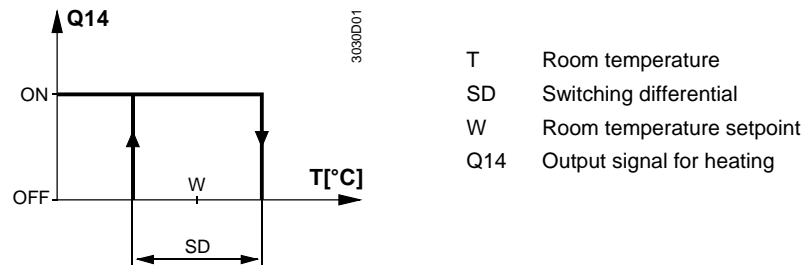

## Operating modes

The RDE10... provides normal operation and, optionally, energy saving mode or OFF. The difference between normal operation and energy saving mode is only the room temperature setpoint. The changeover between the operating modes can be made either automatically according to the 7-day time switch or manually with the operating mode selector.

### Normal operation

When normal operation is activated, symbol “☀” appears on the display. The setpoint can be readjusted by pressing buttons , and .

### Energy saving mode or OFF

When energy saving mode is activated, symbol “☾” appears on the display. The setpoint can be readjusted by pressing buttons , and .

In energy saving mode, the unit can also be switched to “Off”. This is accomplished by selecting a setpoint of 5 °C and then keeping button depressed for 4 seconds. In that case, symbol '☾' does not appear.

### 7-day time switch

The changeover between the operating modes can take place either automatically () or manually (☀, ☾), depending on the position of the operating mode selector. When the operating mode selector is in position “”, changeover will take place automatically according to the selected switching pattern. For every weekday, a specific switching pattern can be selected.

Factory setting:

Day(s)	Normal operation	Energy saving mode
Mo (1) – Fr (5)	6:00 – 8:00 h and 17:00 – 22:00 h	22:00 – 6:00 h and 08:00 – 17:00 h
Sa (6) – Su (7)	7:00 – 22:00 h	22:00 – 7:00 h

The current setpoint can be temporarily readjusted by pressing buttons and . The setpoint will then be reset to its initial value the next time automatic or manual changeover takes place.

When the operating mode selector is set to “☀” or “☾”, the RDE10... will maintain normal operation or energy saving mode respectively.

## Display

The digital display shows the actual room temperature, the time of day, the weekday, the current switching pattern and the symbol of the operating mode currently active. The switching pattern shows normal operation as a double bar and energy saving mode as a single bar with a flashing time pointer. When the heating output is activated, the triangle symbol appears.

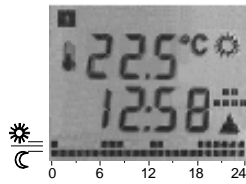

Automatic changeover according to the switching pattern

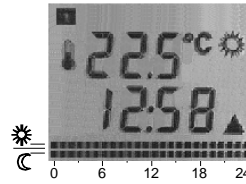

Normal operation

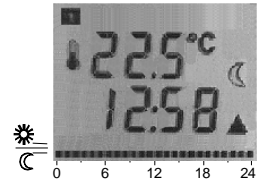

Energy saving mode

## Backup

In the event of a power failure, the setpoints and the information required for operating mode changeover are retained for 3 minutes. This is enough to cope with power failures of short duration (with RDE10) or when changing the batteries (with RDE10.1).

## Type summary

Type reference	Features
<b>RDE10</b>	Mains-powered AC 230 V
<b>RDE10.1</b>	Battery-powered DC 3 V

## Ordering

When ordering, please give name and type references, e.g. **room temperature controller RDE10**.

Valve actuators are to be ordered as separate items.

## Equipment combinations

Type of unit	Type reference	Data sheet
Motoric on/off actuator	<b>SFA21...</b>	4863
Thermal actuator (for radiator valve)	<b>STA21...</b>	4893
Thermal actuator (for small valve 2,5 mm)	<b>STP21...</b>	4878

## Accessories

Description	Type reference
Adapter plate 120 x 120 mm for 4" x 4" conduit boxes	ARG70
Adapter plate 96 x 120 mm for 2" x 4" conduit boxes	ARG70.1
Adapter plate for surface wiring 112x130 mm	ARG70.2

The unit consists of two parts:

- A plastic housing with digital display, which accommodates the electronics, the operating elements and the built-in room temperatures sensor
- A mounting base

The housing engages in the mounting base and snaps on.  
The base carries the screw terminals.

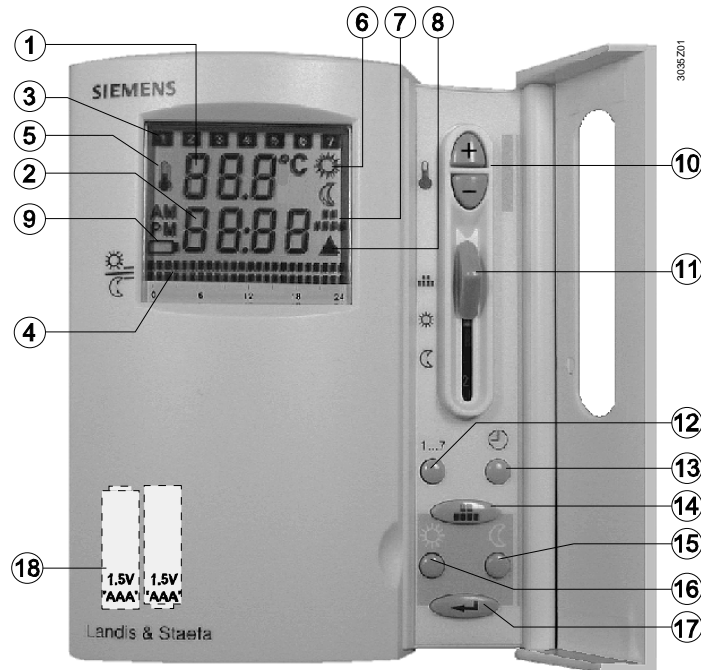

### Legend

- 1 Display of the room temperature in °C or setpoints
- 2 Current time of day using the format 00:00 ... 23:59
- 3 Current weekday from 1 (Monday) to 7 (Sunday)
- 4 Current switching pattern with flashing time pointer
- 5 symbol when actual room temperature is displayed
- 6 Normal operation
- 7 Energy saving mode
- 8 symbol in automatic mode or when selecting the switching pattern
- 9 heating on
- 9 symbol indicating that batteries need to be replaced (only with battery-powered versions)
- 10 Buttons for adjusting the setpoints, the time of day and the switching times
- 11 Operating mode selector
- 12 Setting the weekday
- 13 Setting the time of day
- 14 Selecting and leaving the setting mode for the switching pattern
- 15 Setpoint adjustment for energy saving mode
- 16 Setpoint adjustment for normal operation
- 17 Button for confirming the switching pattern settings
- 18 Battery compartment (only with battery-powered versions)

The room temperature controller should be mounted in a location where the air temperature can be measured as accurately as possible without getting adversely affected by direct solar radiation or other heat or refrigeration sources.

Mounting height is about 1.5 m above the floor.

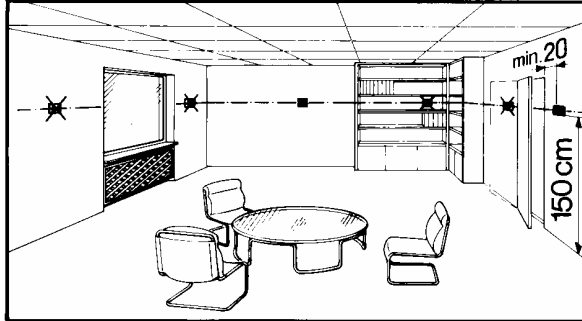

The unit can be fitted to a recessed conduit box.



- Only authorized staff may open the controller.  
**Caution: AC 230 V!**
- The cables used must satisfy the insulation requirements with regard to mains potential





**Mounting, installations and commissioning**

When mounting the unit, fix the baseplate first. Then, make the electrical connections and fit and secure the cover (also refer to separate Mounting Instructions). The controller must be mounted on a flat wall and in compliance with local regulations. If there are thermostatic radiator valves in the reference room, they must be set to their fully open position.

**Maintenance**

The controller is maintenance-free.



**Sensor calibration**

If the temperature on the display does not agree with the room temperature effectively measured, the temperature sensor can be recalibrated. For that purpose, both buttons  and  must be pressed simultaneously for 3 seconds. Then, the temperature displayed can be changed by a maximum of +/- 3 K by pressing the  and  buttons. Five seconds after the last push of a button, the controller will automatically return to the normal operational statuses.



**Change of batteries (only with battery-powered versions)**

If the battery symbol appears, the battery power is almost exhausted and the batteries should be replaced.

**Reset**

To reset, first press and hold the button , then press the two buttons  simultaneously for 3 seconds. All individual settings will be reset to their standard values.

## Technical data

 Power supply	Operating voltage	AC 230 V +10/-15 %
	<ul style="list-style-type: none"> <li>RDE10 at L and N</li> <li>RDE10.1</li> </ul>	DC 3 V (2 x 1.5 V AAA Alkaline - batteries)
	Frequency (RDE10)	50 or 60 Hz
	Power consumption (RDE10)	4VA
	Battery life (RDE10.1)	> 1 years (AAA Alkaline - batteries)
Control outputs	Control output Q12 (N.C. contact)	
	Rating RDE10 (AC 230 V)	max. 5(2) A
	Rating RDE10.1 (AC 24...250 V)	max. 5(2) A
	Control output Q14 (N.O. contact)	
Functional data	Rating RDE10 (AC 230 V)	max. 5(2) A
	Rating RDE10.1 (AC 24...250 V)	max. 5(2) A
	Switching differential SD	1 K
	Setpoint setting range	5...35 °C (normal operation) 0 (OFF) and 5...35 °C (energy saving mode)
	Factory setting normal operation	20 °C
	Factory setting energy saving mode	8 °C
	Resolution of settings and displays	
	Setpoints	0.5 °C
	Switching times	60 min
	Actual value displays	0.5 °C
	Time of day displays	1 min
Environmental conditions	Operation	to IEC 721-3-3
	Climatic conditions	class 3K5
	Temperature	0...+50 °C
	Humidity	<95 % r. h.
	Transport	to IEC 721-3-2
	Climatic conditions	class 2K3
	Temperature	-25...+60 °C
	Humidity	<95 % r. h.
	Mechanical conditions	class 2M2
	Storage	to IEC 721-3-1
Norms and standards	Climatic conditions	class 1K3
	Temperature	-25...+60 °C
	Humidity	<95 % r. h.
	<b>CE</b> conformity to	
	EMC directive	89/336/EEC
	Low voltage directive	73/23/EEC and 93/68/EEC
	 <b>C-Tick</b> conformity to	
	EMC emission standard	AS/NSZ 4251.1:1994
	Product standards	
	Automatic electrical controls for household and similar use	EN 60 730 – 1 and EN 60 730 – 2 - 9
	Electromagnetic compatibility	
	Emissions	IEC/EN 61 000-6-3
	Immunity	IEC/EN 61 000-6-1
	Safety class	II to EN 60730
	Pollution class	normal
Degree of protection of housing	IP30 to EN 60529	

General

Connection terminals for	Use solid wires or prepared stranded wires. 2 x 1.5 mm <sup>2</sup> or 1 x 2.5 mm <sup>2</sup> (min. 0.5 mm <sup>2</sup> )
Weight	0.21 kg
Colour of housing front	white, NCS S 0502-G (RAL 9003)

**Connection diagram**

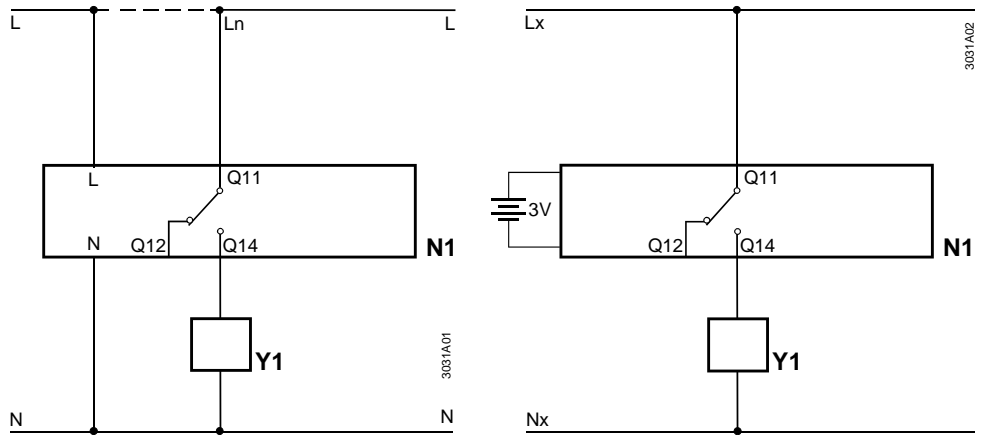

RDE10

RDE10.1

- |              |                             |                 |                                |
|--------------|-----------------------------|-----------------|--------------------------------|
| <b>N1</b>    | Room temperature controller | <b>Q11, Q12</b> | N.C. contact (for N.O. valves) |
| <b>Y1</b>    | Regulating unit             | <b>Q11, Q14</b> | N.O. contact (for N.C. valves) |
| <b>L, Ln</b> | Live, AC 230 V              | <b>Nx</b>       | Neutral, AC 24 ... 250 V       |
| <b>N</b>     | Neutral, AC 230 V           |                 |                                |
| <b>Lx</b>    | Live, AC 24 ... 250 V       |                 |                                |

**Application examples**

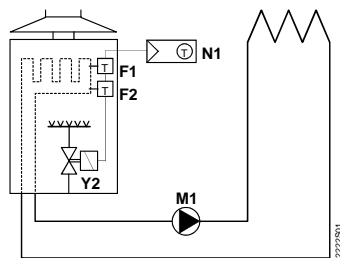

Room temperature controller with direct control of a gas-fired wall-hung boiler

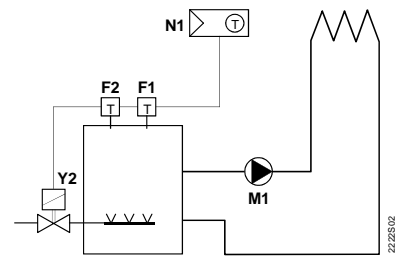

Room temperature controller with direct control of a gas-fired floor-standing boiler

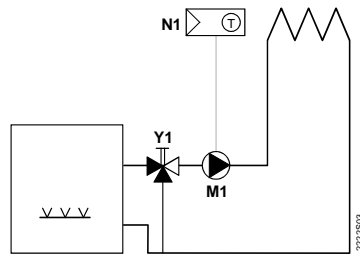

Room temperature controller with direct control of a heating circuit pump (precontrol by manual mixing valve)

F1	Thermal reset limit thermostat	N1	RDE10... room temperatures controller
F2	Safety limit thermostat	Y1	3-port valve with manual adjustment
M1	Circulating pump	Y2	Magnetic valve

## Dimensions

### Controller

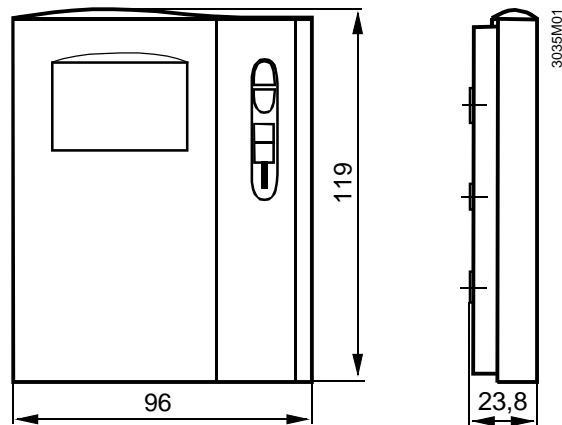

### Baseplate

